



- ▶ Panel PC durci "Tout-en-un"
- ▶ Solution sans ventilation (Fanless)
- ▶ Face avant trueflat - Dalle tactile Multitouch PCAP
- ▶ Étanche IP65 en face avant - Protection aux chocs IK08
- ▶ Écran LCD TFT 15.6" Wide - Résolution HD 1366x768
- ▶ Disponible en différentes versions de processeurs Intel®
- ▶ Cache câbles avec joint de maintien
- ▶ Alimentation industrielle interne AC ou DC large plage
- ▶ Garantie standard 5 ans pièces et main-d'œuvre retour atelier

Les +

- ▶ Boîtier option dans la poignée
- ▶ Panel PC "Tout-en-un"
- ▶ IP65 face avant & Résistance IK08
- ▶ Alimentation industrielle **intégrée**



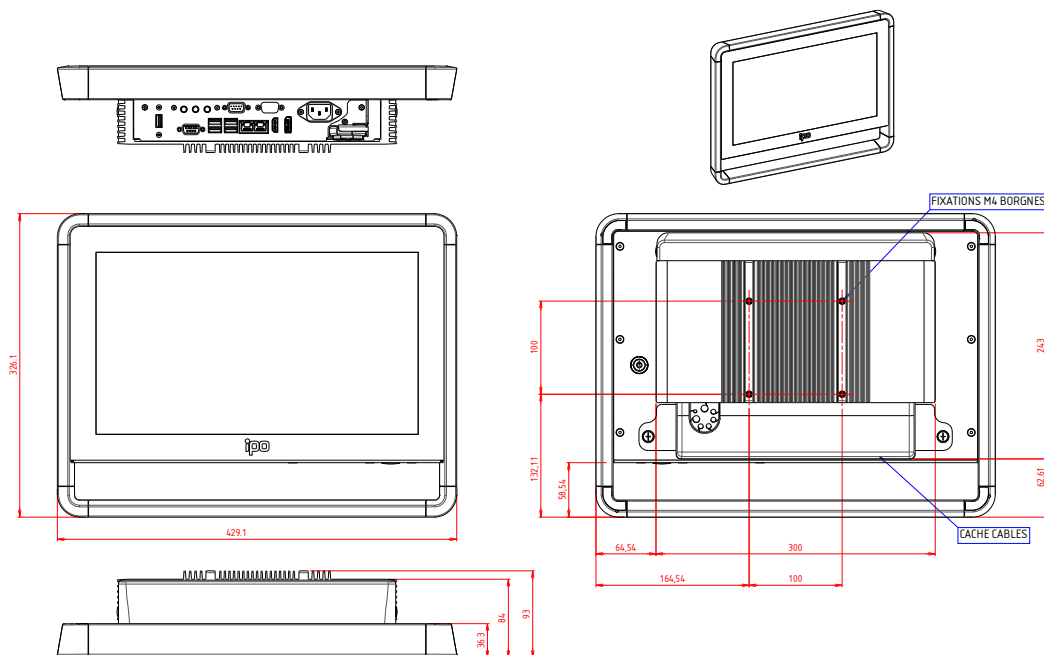







Plan d'implantation













Référence de commande

FUTURA15WQPA-CV-***	Panel PC "Tout-en-un" True-flat fanless durci - Coffret avec poignée - IP65&IK08 face avant - 15.6" HD - Intel® Pentium® QC N4200 - Dalle tactile PCAP - Alimentation à choisir
FUTURA15WCIC-CV-***	Panel PC "Tout-en-un" True-flat fanless durci - Coffret avec poignée - IP65&IK08 face avant - 15.6" HD - Intel® Core™ i5-1145G7E - Dalle tactile PCAP - Alimentation à choisir

** : Préciser l'alimentation choisie : **AC** Interne 230VAC ou **DC** 9-36VDC

 Système	
Nom du produit	FUTURA-15WQP
Processeur Intel®	Pentium® N4200 Quad Core (1.1/2.5GHz) – TPM (2.0)
Mémoire	2 x DDR3L-1866 SO-DIMM (max. 8Go)
Emplacements	1 x 2”1/2 SATA + 1 x mSATA + 1 x M.2 (B-key)
Système d'exploitation	Win 10 IoT Enterprise – Win 10 PRO – Win 11 PRO compatible Linux sur demande
Connectique	4 x USB 3.0 – 1 x USB 2.0 2 x RS232 2 x Gigabit Ethernet (RJ45) 1 x Display port – 1 x HDMI – 1 x Bloc audio
 Châssis	
Coffret	Aluminium traité – épaisseur 2mm
Cadre	Profilé aluminium anodisé épaisseur 1.5mm
Coins	En polycarbonate – standard noir – personnalisable
Face avant	Dalle tactile true-flat – épaisseur 2.5mm
Couleur	Noir – Châssis arrière peinture texturée noir RAL9005
Solution de fixation	Empreinte VESA 100 intégrée au dissipateur
Cache Prise	Avec joint de passage – maintien des câbles
Audio	Haut-Parleur 1x3W
 Protection	
Face avant	Étanchéité IP65 face avant
Châssis	Protection aux chocs IK08
 Commande / voyant	
En face arrière	Bouton marche/arrêt rétro-éclairé Réglage de luminosité (Applicatif logiciel sous Windows)
 Environnement	
Temp. de fonctionnement	0° ~ + 45°C (QP) – 0° ~ + 40°C (CIC)
Temp. de stockage	- 20 + 60°C
Humidité sans condensation	5 95 %
 Ventilation	
Type de ventilation	Fanless Refroidissement par convection naturelle
 Affichage / Ecran	
Taille / Diagonale	15.6” Wide – Technologie backlight LED
Surface d'affichage	344 x 193 mm
Résolution native	1366 x 768 HD
Nombre de couleurs	16.2 millions
Pas de masque (pixel)	0.252 mm
Luminosité	500 cd/m²
Contraste	500:1
Angle de vision max.	Horizontal : 170° – Vertical : 160°
 Dalle tactile	
Technologie	Capacitive projetée Multi-touch (10 points)
Résistance	6H
 Alimentation Industrielle	
Version AC-	Entrée : 115/230VAC – Fréquence : 50/60Hz
Version DC	Entrée large plage: 9-36VDC Protection inversion polarité – Isolation galvanique
Puissance consommée	Version QP 75W max. / Version CI 80W max.
 Normes & Certifications	
Sécurité	EN 62368-1
EMC	EN 55032 / EN 55024 EN 61000-3-2 / EN 61000-3-3
 Dimensions	
Dimensions (LxHxP)	429.1 x 326.1 x 93 mm
Poids net en kg	5.5

Options & Accessoires

	ZFUT-PT	Support Pied de table VESA – inclinable		ZFUT-SUP-CLAV	Support clavier
	ZFUT-BT	Support bras articulé – fixation table		FUT-SUP-DOUCH	Support douchette
	ZFUT-BM	Support bras articulé – fixation Mur		ZFUT-ARGOS	Support Pupitre réglable
	PIED-TUBE-L1400	Support Pied Tube sol – Format carré – Hauteur : 1400mm		ZFUT-WIFI-2-A	Solution Wifi 5 +Bluetooth Version QP
				FUT-WIFI-BT-CIC	Solution Wifi 6 +Bluetooth Version CI
	Boîtier option : dans le cadre sous la machine Sortie en face avant ou arrière – différentes tailles permettant une intégration sur mesure : Lecteur RFID, Arrêt urgence, Touches de fonction, USB, RS-232, Lan, ...				

Liste de colisage

1 x Câble secteur CE22 1.80 m (Version AC~)	1 x Licence des logiciels (format étiquette)	1 x Fiche de Production & Tracabilité
---	--	---------------------------------------