



- ▶ Solution Panel PC True-flat en coffret
- ▶ Solution sans ventilation (Fanless)
- ▶ Étanche IP65 en face avant
- ▶ Protection aux chocs IK08
- ▶ Ecran LCD TFT 21.5" Wide - Résolution Full HD 1920x1080
- ▶ Disponible en différentes versions de processeurs Intel®
- ▶ Face avant trueflat - Dalle tactile Multitouch PCAP
- ▶ Alimentation industrielle interne **AC** ou **DC** large plage
- ▶ Garantie standard 2 ans pièces et main-d'œuvre retour atelier

Les +

- ▶ Face avant **True-flat**
- ▶ Panel PC "**Tout-en-un**"
- ▶ **IP65** face avant & Résistance **IK08**
- ▶ Alimentation industrielle **intégrée**

Plan d'implantation



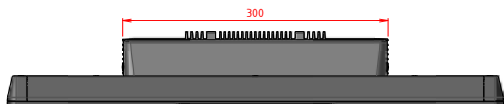
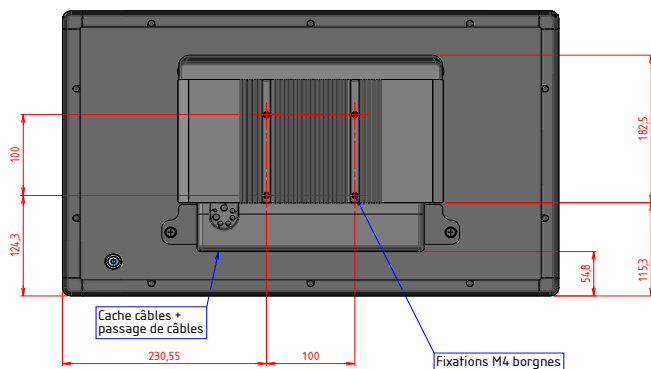
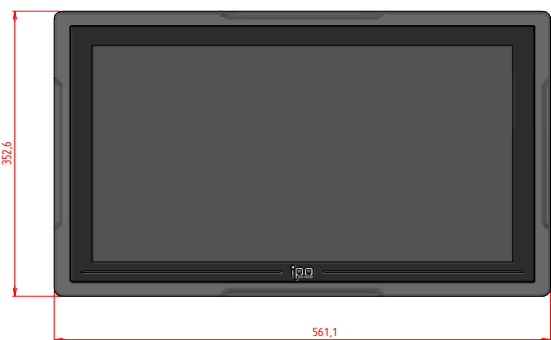
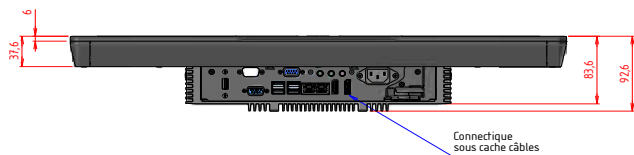







VERSION CIC









Référence de commande

VITUS21WQPA-CV-***	Panel PC Trueflat fanless industriel - en coffret - IP65 face avant - 21.5" Full HD - Intel® Pentium® N4200 Quad Core - Dalle tactile PCAP - Alimentation industrielle interne à choisir
VITUS21WCIC-CV-***	Panel PC Trueflat fanless industriel - en coffret - IP65 face avant - 21.5" Full HD - Intel® Core™ i5-1145G7E - Dalle tactile PCAP - Alimentation industrielle interne à choisir

** : Préciser l'alimentation choisie : **AC** Interne 230VAC ou **DC** 9-36VDC

 Système	
Nom du produit	VITUS-21WQP
Processeur Intel®	Pentium® N4200 Quad Core (1.1/2.5GHz) – TPM (2.0)
Mémoire	2 x DDR3L-1866 SO-DIMM (max. 8.0 Go)
Emplacements	1 x 2 1/2 SATA + 1 x mSATA + 1 x M.2 (B-key)
Système d'exploitation	Win 10 IoT Enterprise – Win 10 PRO – Win 11 PRO compatible Linux sur demande
Connectique	4 x USB 3.0 – 1 x USB 2.0 2 x RS232 2 x Gigabit Ethernet (RJ45) 1 x Display port – 1 x HDMI – 1 x Bloc audio
 Châssis	
Coffret	Aluminium traité – épaisseur 2mm
Cadre	Aluminium traité peint – épaisseur 1.5mm
Face avant	Dalle tactile true-flat – Aluminium anodisé noir ép. 2.5mm
Couleur	Noir – peinture texturée noir RAL9005
Coins	En polycarbonate – standard noir – personnalisable
Solution de fixation	Empreinte VESA 100 intégrée au dissipateur
Cache Prise	Avec joint de passage – maintien des câbles
Audio	Haut-Parleur 1x3W
 Protection	
Face avant	Étanchéité IP65 face avant
Châssis	Protection aux chocs IK08
 Commande / voyant	
En face arrière	Bouton marche/arrêt rétro-éclairé Réglage de luminosité (Applicatif logiciel sous Windows)
 Environnement	
Temp. de fonctionnement	0° ~ + 45°C (QAB) – 0° ~ + 40°C (CIC)
Temp. de stockage	- 20 + 60°C
Humidité sans condensation	5 95 %
 Ventilation	
Type de ventilation	Fanless Refroidissement par convection naturelle
 Affichage / Ecran	
Taille / Diagonale	21.5" Wide – Technologie backlight LED
Surface d'affichage	476 x 268 mm
Résolution native	1920 x 1080 Full HD
Nombre de couleurs	16.7 millions
Pas de masque (pixel)	0.248 mm
Luminosité	350 cd/m²
Contraste	5000:1
Angle de vision max.	Horizontal : 178° – Vertical : 178°
 Dalle tactile	
Technologie	Capacitive projetée Multi-touch (10 points)
Résistance	6H
 Alimentation industrielle	
Versión AC~	Entrée : 115/230VAC – Fréquence : 50/60Hz
Versión DC	Entrée large plage: 9-36VDC Protection inversion polarité – Isolation galvanique
Puissance consommée	Versión QP 90W max. / Versión CI 95W max.
 Normes & Certifications	
Sécurité	EN 62368-1
EMC	EN 55032 / EN 55024 EN 61000-3-2 / EN 61000-3-3
 Dimensions	
Dimensions (LxHxP)	561.1 x 352.6 x 92.6 mm
Poids net en kg	8.5

Options & Accessoires

	ZFUT-PT	Support Pied de table VESA – inclinable		SUP-MUR-VE-SA100-2	Support mural inclinable et orientable – VESA
	ZFUT-BT	Support bras articulé – fixation table		ZFUT-WIFI-2-A	Solution Wifi 5 + Bluetooth pour série QP
	ZFUT-BM	Support bras articulé – fixation Mur		FUT-WIFI-BT-CIC	Solution Wifi 6 + Bluetooth pour série CIC
	PIED-TUBE-L1400	Support Pied Tube sol – Format carré – Hauteur : 1400mm			
	ADAP-PIED-TUBE-W	Adaptateur fixation FUTURA – VITUS/THETIS W – sur ancien Pied Tube			

Liste de colisage

1 x Câble secteur CE22 1.80 m (Version AC~)	1 x Licence des logiciels (format étiquette)	1 x Fiche de Production & Tracabilité
---	--	---------------------------------------