



- ▶ Solution Panel PC encastrable - Face avant métal
- ▶ Solution sans ventilation (Fanless)
- ▶ Étanche IP65 en face avant
- ▶ Écran LCD TFT 15" 4:3 - Résolution XGA 1024x768
- ▶ Disponible en différentes versions de processeurs Intel®
- ▶ **Versión sans dalle** : Vitre de protection de l'écran
- ▶ **Versión avec dalle** : Technologie résistive
- ▶ Alimentation industrielle interne **AC** ou **DC** large plage
- ▶ **Option** : face avant inox - face avant rackable - ...
- ▶ Garantie standard 2 ans pièces et main-d'œuvre retour atelier

Les +

- ▶ Disque dur - Maintenance facile
- ▶ Option **face avant** disponible
- ▶ **IP65** face avant
- ▶ Alimentation industrielle **intégrée**



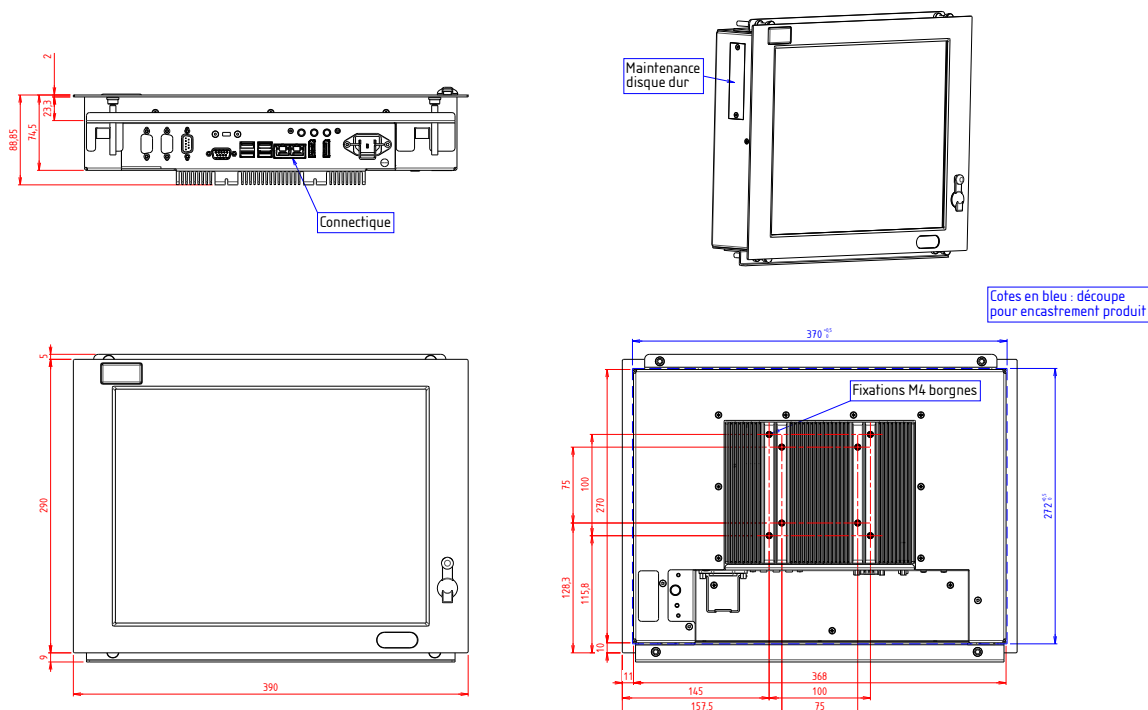







Plan d'implantation



Référence de commande

THETIS15QPA-NT-**-**	Panel PC industriel - encastrable - IP65 face avant - 15" XGA - Intel® Pentium® N4200 Quad Core - Vitre de protection - Alimentation industrielle interne à choisir	THETIS15QPA-RT-**-**	Panel PC industriel - encastrable - IP65 face avant - 15" XGA - Intel® Pentium® N4200 Quad Core - Dalle tactile résistive - Alimentation industrielle interne à choisir
THETIS15CIC-NT-**-**	Panel PC industriel - encastrable - IP65 face avant - 15" XGA - Intel® Core™ i5-1145G7E - Vitre de protection - Alimentation industrielle interne à choisir	THETIS15CIC-RT-**-**	Panel PC industriel - encastrable - IP65 face avant - 15" XGA - Intel® Core™ i5-1145G7E - Dalle tactile résistive - Alimentation industrielle interne à choisir

** : Préciser l'alimentation choisie : **AC** Interne 230VAC ou **DC** 9-36VDC

		Système	
			
Nom du produit	THETIS-15QP	Nom du produit	THETIS-15CIC
Processeur Intel®	Pentium® N4200 Quad Core (1.1/2.5GHz) – TPM (2.0)	Processeur Intel®	Core™ i5-1145G7E (1.5GHz/4.1GHz) – TPM (2.0)
Mémoire	2 x DDR3L-1866 SO-DIMM (max. 8.0 Go)	Mémoire	2 x DDR4-3200 SO-DIMM (max. 64Go)
HDD / SSD	1 x 2"1/2 SATA + 1 x mSATA + 1 x M.2 (B-key)	Emplacements	1 x 2"1/2 SATA + 3 x M.2 sockets (B-Key/E-Key/M-Key)
Système d'exploitation	Win 10 IoT Enterprise – Win 10 PRO – Win 11 PRO compatible Linux sur demande	Système d'exploitation	Win 10 IoT Enterprise – Win 10 PRO – Win 11 PRO Linux sur demande
Connectique	4 x USB 3.0 – 1 x USB 2.0 (version non tactile) 3 x RS232 – 1 x USB 2.0 face avant avec protection 2 x Gigabit Ethernet (RJ45) – 1 x Keylock 1 x Display port – 1 x HDMI – 1 x Bloc audio	Connectique	3 x USB 3.1 – 1 x USB 2.0 – 1 x USB 2.0 face avant 2 x RS232 – 2 x COM option 2 x Gigabit Ethernet (RJ45) – 1 x Keylock 2 x Display port – 1 x Bloc audio
	Châssis		Affichage / Ecran
Coffret	Tôle aluminium traité 1.5 mm d'épaisseur	Taille / Diagonale	15" – Technologie backlight LED
Face avant	2 mm d'épaisseur – Peinture noire RAL-7021 Joint d'étanchéité	Surface d'affichage	304 x 228 mm
Maintenance HDD	Trappe de maintenance facile	Résolution native	1024 x 768 XGA
Version sans dalle tactile	Vitre antireflet protégeant l'écran – 3 mm	Nombre de couleurs	16 millions
Version dalle tactile	Dalle antiglare (3H) – 3.3 mm	Pas de masque (pixel)	0.297 mm
Solution de fixation	Encastrable avec Taquets de blocage (x2) Empreinte VESA 75/100 intégrée au dissipateur	Luminosité	400 cd/m²
	Protection	Contraste	1500:1
Face avant	Étanchéité IP65 face avant	Angle de vision max.	Horizontal : 170° – Vertical : 170°
	Commande / voyant		Dalle tactile
En face arrière	Bouton marche/arrêt Bouton Reset Voyant alimentation – Voyant activité HDD	Technologie	Résistive (5 fils)
En face avant	Touches de réglage de luminosité	Résistance	3H
	Environnement		Alimentation industrielle
Temp. de fonctionnement	0° ~ + 45°C (QP) – 0° ~ + 35°C (CIC)	Version AC~	Entrée : 115/230VAC – Fréquence : 50/60Hz
Temp. de stockage	- 20 + 60°C	Version DC	Entrée large plage: 9-36VDC Protection inversion polarité – Isolation galvanique
Humidité sans condensation	5 95 %	Puissance consommée	Version QP 75W max. / Version CI 95W max.
	Ventilation		Normes & Certifications
Type de ventilation	Fanless Refroidissement par convection naturelle	Sécurité	EN 62368-1
		EMC	EN 55032 / EN 55024 EN 61000-3-2 / EN 61000-3-3
			Dimensions
		Dimensions (LxHxP)	390 x 290 x 89
		Poids net en kg	9.2

Options & Accessoires

	FA19-15	Face avant au format 19" – Hauteur 7U		ENC-RFID	Boîtier RFID LF – encastrable
	FA-INOX-15	Face avant inox 316L (supprime l'USB de la face avant)		ENC-RFID-HF	Boîtier RFID HF – encastrable
	RS485X1	Option port 1 x RS485 (remplace RS232 existant)		ENC-2XUSB	Boîtier 2 x USB – encastrable
	RS485X1-I	Option port 1 x RS485 isolé (remplace RS232 existant)		ENC-URG	Boîtier Bouton Arrêt d'urgence – encastrable
				ENC-CLAV12T	Boîtier touches de fonctions (12) – encastrable

Liste de colisage

1 x Câble secteur CE22 1.80 m (Version AC~)	1 x Licence des logiciels (format étiquette)	1 x Fiche de Production & Tracabilité
2 x Taquets de blocage		