



- ▶ Solution sans ventilation (Fanless)
- ▶ Face avant True-flat en inox 316L
- ▶ Encastrement simple par brides de fixation
- ▶ Protection : IP69 face avant
- ▶ Écran LCD TFT 18.5" Wide
- ▶ Résolution Full HD 1920 x 1080
- ▶ Disponible en différentes versions de processeurs Intel®
- ▶ Version **CV** : Dalle tactile PCAP Verre (6H)
- ▶ Version **CP** : Dalle tactile PCAP plastique PMMA (6H)
- ▶ Version **TR** : Dalle tactile résistive 5-fils (4H)
- ▶ Alimentation industrielle interne **AC** ou **DC** large plage
- ▶ Garantie standard 2 ans pièces et main-d'œuvre retour atelier

Les +

- ▶ Encastrement **facile**
- ▶ Face avant **True-flat**
- ▶ Face avant **inox 316L**
- ▶ Étanche **IP69** face avant

Plan d'implantation



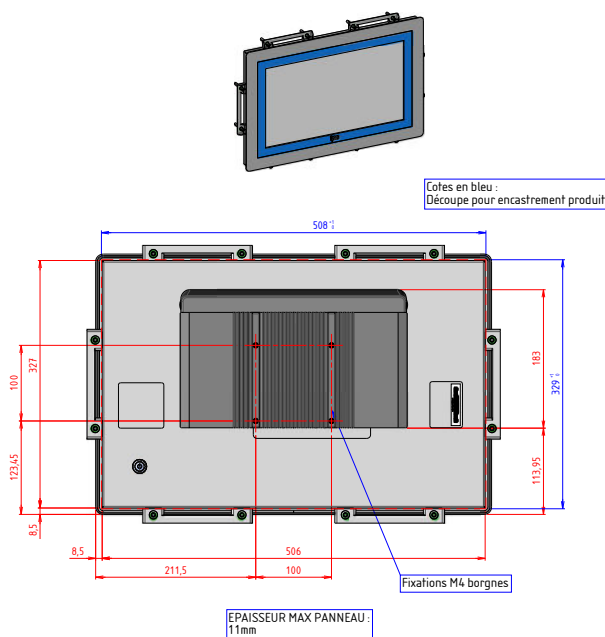
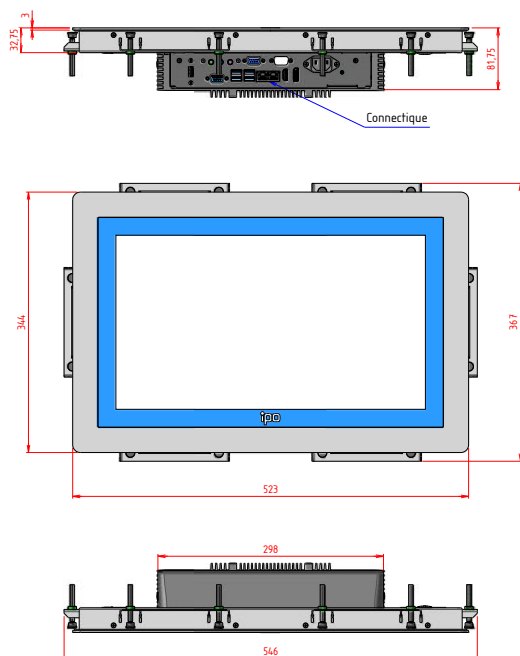







Plan de la version avec Dalle CP









Référence de commande

TITAP18WQPA-CV-**-**	Panel PC fanless industriel - encastrable - IP69 face avant - 15.6" HD - Intel® Core™ i5-7300U - Dalle tactile PCAP Verre (6H) - Préciser l'alimentation choisie	TITAP18WCIC-CV-**-**	Panel PC fanless industriel - encastrable - IP69 face avant - 18.5" Full HD - Intel® Core™ i5-1145G7E - Dalle tactile PCAP Verre - Préciser l'alimentation choisie
TITAP18WQPA-CP-**-**	Panel PC Fanless industriel - coffret inox 316L - IP69 face avant/IP66 coffret - 18.5" Full HD - Intel® Pentium® Quad Core N4200 - Dalle tactile PCAP PMMA - Préciser l'alimentation choisie	TITAP18WCIC-CP-**-**	Panel PC fanless industriel - encastrable - IP69 face avant - 18.5" Full HD - Intel® Core™ i5-1145G7E - Dalle tactile PCAP PMMA - Préciser l'alimentation choisie
TITAP18WQPA-TR-**-**	Panel PC Fanless industriel - coffret inox 316L - IP69 face avant/IP66 coffret - 18.5" Full HD - Intel® Pentium® Quad Core N4200 - Dalle tactile résistive - Préciser l'alimentation choisie	TITAP18WCIC-TR-**-**	Panel PC fanless industriel - encastrable - IP69 face avant - 18.5" Full HD - Intel® Core™ i5-1145G7E - Dalle tactile résistive - Préciser l'alimentation choisie

** : Préciser l'alimentation choisie : **AC** Interne 230VAC ou **DC** 9-36VDC

 Système	
Nom du produit	TITAN P 18WQP
Processeur Intel®	Pentium® N4200 Quad Core (1.1/2.5GHz) – TPM (2.0)
Mémoire	2 x DDR3L-1866 SO-DIMM (max. 8.0 Go)
Emplacements	1 x 2"1/2 SATA + 1 x mSATA + 1 x M.2 (B-key)
Système d'exploitation	Win 10 IoT Enterprise – Win 10 PRO – Win 11 PRO compatible
	Linux sur demande
Connectique	4 x USB 3.0 – 1 x USB 2.0
	2 x RS232
	2 x Gigabit Ethernet (RJ45)
	1 x Display port – 1 x HDMI – 1 x Line-out
 Châssis	
Coffret (Arrière)	Inox F17 – Epaisseur 1.5mm
Face avant	Inox 316L – Epaisseur 3mm
	True-flat – Cadre interne CV/TR : Noir – CP : Bleu
	Joint d'étanchéité
Solution de fixation	Taquet de blocage (x6)
	Empreinte VESA 100x100
Dalle tactile	Dalle verre traitement antirayure (6H) – 3mm
	Dalle plastique PMMA (6H) – 4mm
 Protection	
Face avant	Étanchéité IP69 face avant
Encastrement	Étanchéité IP66
Résistance	Protection aux chocs IK08 – zone d'affichage
 Commande / voyant	
En face arrière	Bouton marche/arrêt rétro-éclairé
	Réglage de luminosité (Applicatif logiciel sous Windows)
 Environnement	
Temp. de fonctionnement	0° ~ + 45°C (QP) – 0° ~ + 35°C (CIC)
Temp. de stockage	- 20 + 60°C
Humidité sans condensation	5 95 %
 Ventilation	
Type de ventilation	Fanless
	Refroidissement par convection naturelle
 Affichage / Ecran	
Taille / Diagonale	18.5" Wide – Technologie Backlight LED
Surface d'affichage	344 x 193 mm
Résolution native	Full HD 1920 x 1080
Nombre de couleurs	16.7 millions
Pas de masque (pixel)	0.213 mm
Luminosité	350 cd/m²
Contraste	1000:1
Angle de vision	Horizontal : 178° – Vertical : 178°
 Dalle tactile	
Versión CV couleur noir	Capacitive projetée Multi-touch (10 points)
Versión CP couleur bleu	Capacitive projetée Multi-touch PMMA (10 points)
Versión TR couleur noir	Dalle résistive (5-fils) antireflet (4H)
 Alimentation industrielle	
Versión AC-	Entrée : 115/230VAC – Fréquence : 50/60Hz
Versión DC	Entrée large plage: 9-36VDC
	Protéc. inversion polarité – Isolation galvanique
Puissance consommée	Versión QP : 75W max / Versión CI : 80W max
 Normes & Certifications	
Sécurité & Protection	EN 62368-1
EMC	EN 55032 / EN 55024
	EN 61000-3-2 / EN 61000-3-3
 Dimensions	
Dimensions (LxHxP)	523 x 344 x 91.75 mm
Poids net en kg	Versión CV/TR : 9 – Versión CP : 8

Options & Accessoires

	ENC-RFID	Boîtier RFID LF - encastrable		ENC-CLAV12T	Boîtier touches de fonctions (12) - encastrable
	ENC-RFID-HF	Boîtier RFID HF - encastrable		ZFUT-SUP-CLAV	Port USB x1 avec protection IP65 – à encastrer
	ENC-2XUSB	Boîtier 2 x USB - encastrable		RS232X1-W-CA	Option port 1 x RS-232 supplémentaires
	ENC-URG	Boîtier Bouton Arrêt d'urgence - encastrable			

Liste de colisage

1 x Câble secteur CE22 1.80 m (Version AC-)	1 x Licence des logiciels (format étiquette)	1 x Fiche de Production & Tracabilité
6 x Taquets de blocage		