

PLAN D'IMPLANTATION ODYSSEE18WQCA-CP

VUE DE FACE

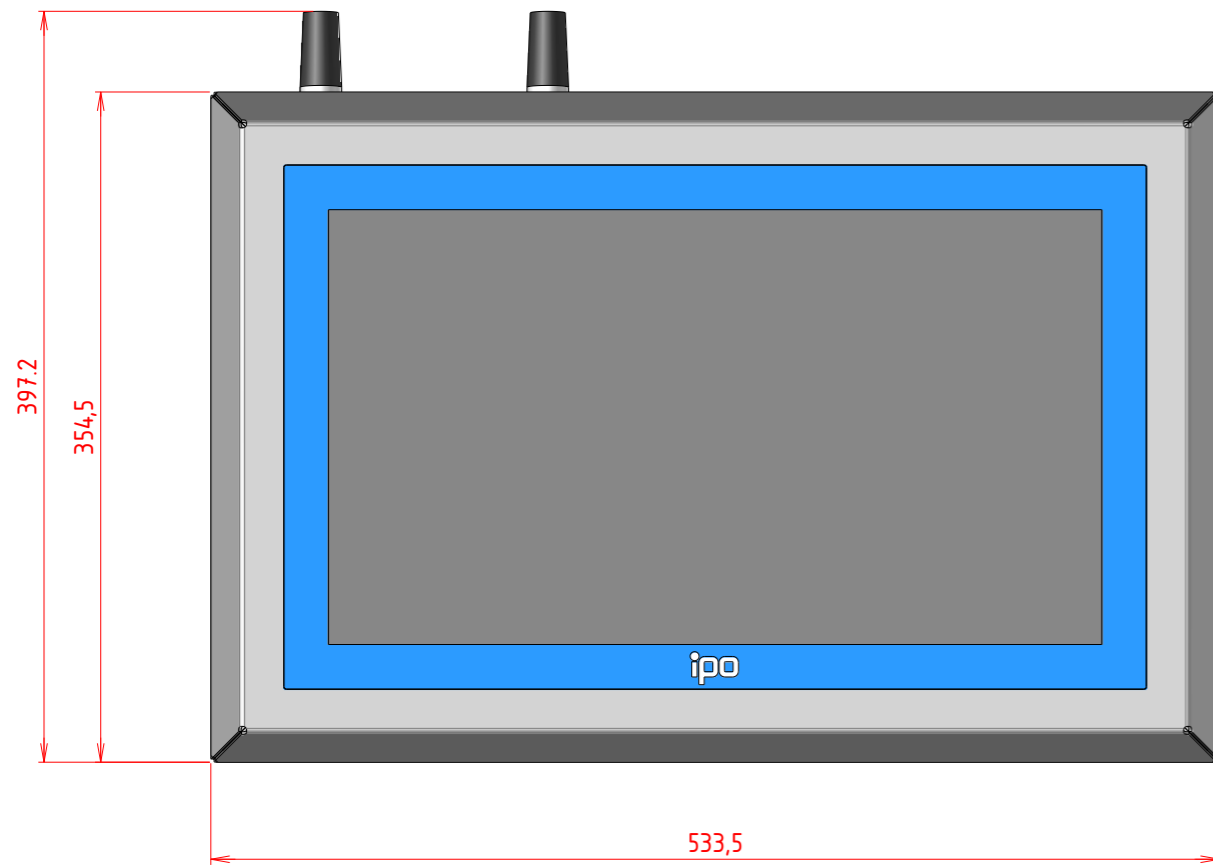

VUE ARRIERE

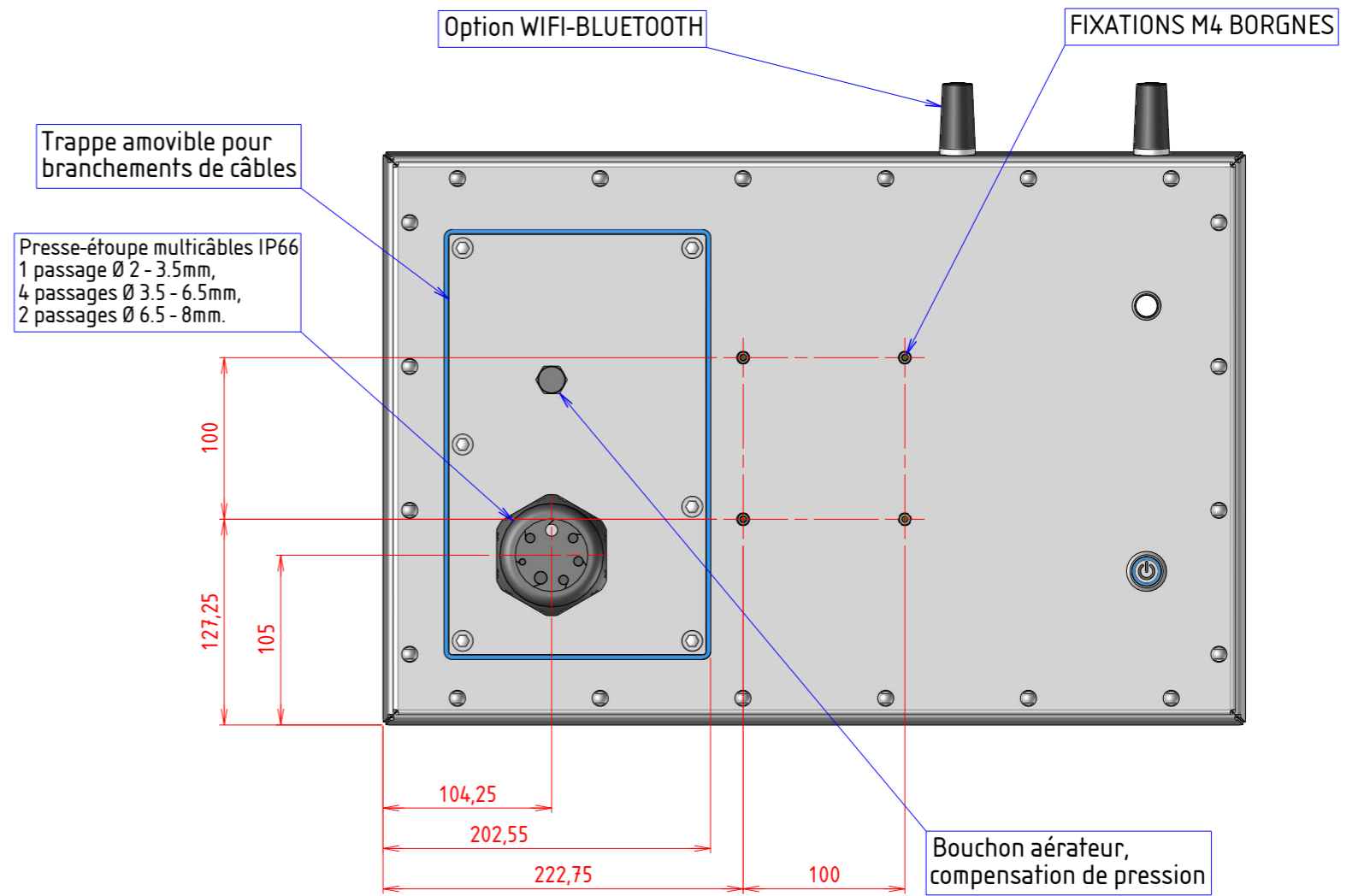

VUE DE DESSUS

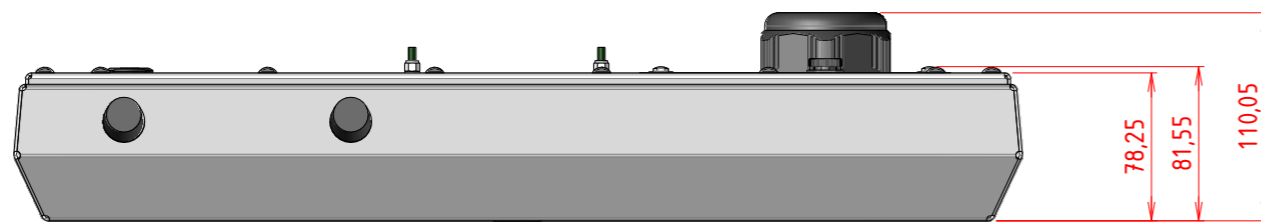

PERSPECTIVE

