



- ▶ Panel PC durci "Tout-en-un"
- ▶ Solution sans ventilation (Fanless)
- ▶ Face avant trueflat - Dalle tactile Multitouch PCAP
- ▶ Étanche IP65 en face avant - Protection aux chocs IK08
- ▶ Écran LCD TFT 21.5" Wide - Résolution Full HD 1920x1080
- ▶ Disponible en différentes versions de processeurs Intel®
- ▶ Cache câbles avec joint de maintien
- ▶ Alimentation industrielle interne AC ou DC large plage
- ▶ Garantie standard 5 ans pièces et main-d'œuvre retour atelier

Les +

- ▶ **Boîtier option** dans la poignée
- ▶ Panel PC "**Tout-en-un**"
- ▶ **IP65** face avant & Résistance **IK08**
- ▶ Alimentation industrielle **intégrée**



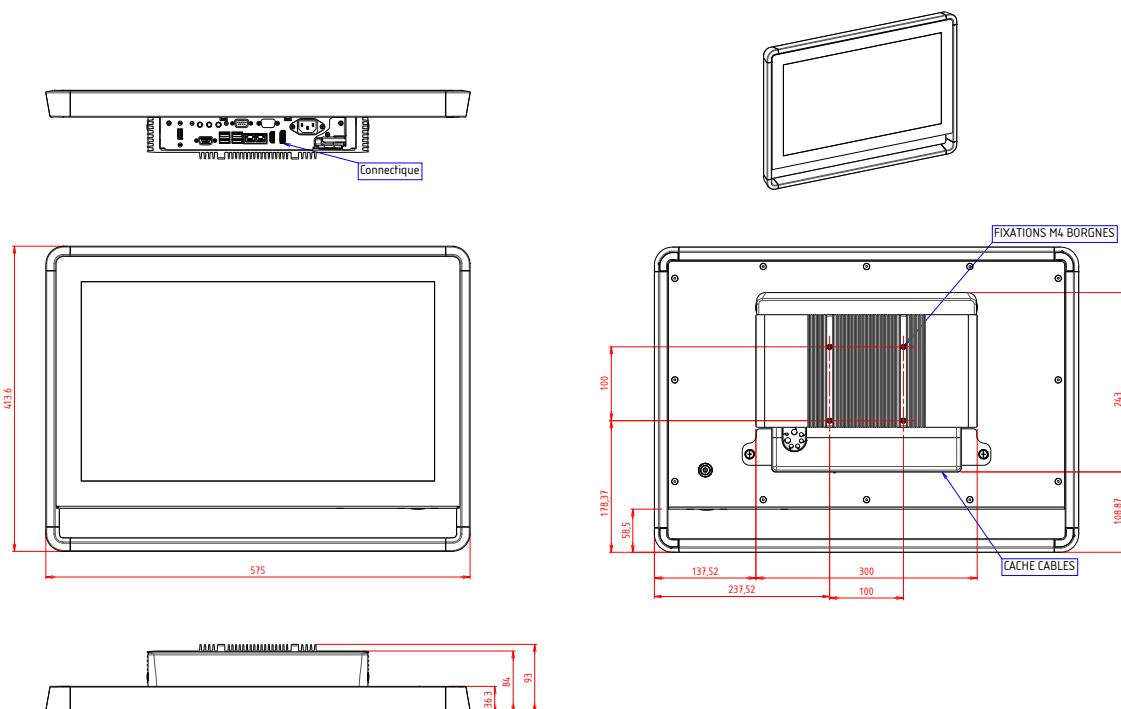







Plan d'implantation













Référence de commande

FUTURA21WQCA-CV-**	Panel PC "Tout-en-un" True-flat fanless durci - Coffret avec poignée - IP65&IK08 face avant - 21.5" Full HD - Intel® Celeron® QC J6412 - Dalle tactile PCAP - Alimentation à choisir
FUTURA21WCIC-CV-**	Panel PC "Tout-en-un" True-flat fanless durci - Coffret avec poignée - IP65&IK08 face avant - 21.5" Full HD - Intel® Core™ i5-1145G7E - Dalle tactile PCAP - Alimentation à choisir

** : Préciser l'alimentation choisie : **AC** Interne 230VAC ou **DC** 9-36VDC

 Système	
Nom du produit	FUTURA-21WQCA
Processeur Intel®	Celeron® QC J6412 (2.0GHz/2.6GHz) - fTPM
Mémoire	1 x DDR4-3200 SO-DIMM (max. 16Go)
Emplacements	1xSATA III +1xmSATA +2xM.2(E-key&B-key) / 1xMini PCI-E
Système d'exploitation	Windows : 10 IoT Enterprise - 10 PRO - 11 PRO Linux sur demande
Connectique	4 x USB 3.1 - 1 x USB 2.0 3 x RS232 2 x Gigabit Ethernet (RJ45) 1 x Display port - 1 x Bloc audio
 Châssis	
Coffret	Aluminium traité - épaisseur 2mm
Cadre	Profilé aluminium anodisé épaisseur 1.5mm
Coins	En polycarbonate - standard noir - personnalisable
Face avant	Dalle tactile true-flat - épaisseur 3.9mm
Couleur	Noir - Châssis arrière peinture texturée noir RAL9005
Solution de fixation	Empreinte VESA 100 intégrée au dissipateur
Cache Prise	Avec joint de passage - maintien des câbles
Audio	Haut-Parleur 1x3W
 Protection	
Face avant	Étanchéité IP65 face avant
Châssis	Protection aux chocs IK08
 Commande / voyant	
En face arrière	Bouton marche/arrêt rétro-éclairé Réglage de luminosité (Applicatif logiciel sous Windows)
 Environnement	
Temp. de fonctionnement	0° ~ + 40°C
Temp. de stockage	- 20 + 60°C
Humidité sans condensation	5 95 %
 Ventilation	
Type de ventilation	Fanless Refroidissement par convection naturelle
 Affichage / Ecran	
Taille / Diagonale	21.5" Wide - Technologie Backlight LED
Surface d'affichage	476 x 268 mm
Résolution native	1920 x 1080 Full HD
Nombre de couleurs	16.7 millions
Pas de masque (pixel)	0.248 mm
Luminosité	300 cd/m²
Contraste	5000:1
Angle de vision max.	Horizontal : 178° - Vertical : 178°
 Dalle tactile	
Technologie	Capacitive projetée Multi-touch (10 points)
Résistance	6H
 Alimentation Industrielle	
Version AC-	Entrée : 115/230VAC - Fréquence : 50/60Hz
Version DC	Entrée large plage: 9-36VDC Protection inversion polarité - Isolation galvanique
Puissance consommée	Versión QP 90W max. / Version CI 95W max.
 Normes & Certifications	
Sécurité	EN 62368-1
EMC	EN 55032 / EN 55024 EN 61000-3-2 / EN 61000-3-3
 Dimensions	
Dimensions (LxHxP)	575 x 413.6 x 93 mm
Poids net en kg	8.5

Options & Accessoires

	ZFUT-PT	Support Pied de table VESA - inclinable		ZFUT-SUP-CLAV	Support clavier
	ZFUT-BT	Support bras articulé - fixation table		FUT-SUP-DOUCH	Support douchette
	ZFUT-BM	Support bras articulé - fixation Mur		ZFUT-ARGOS	Support Pupitre réglable
	PIED-TUBE-L1400	Support Pied Tube sol - Format carré - Hauteur : 1400mm		FUT-WIFI-BT-QCA	Solution Wifi 6 +Bluetooth Version QC
				FUT-WIFI-BT-CIC	Solution Wifi 6 +Bluetooth Version CI
	Boîtier option : dans le cadre sous la machine Sortie en face avant ou arrière - différentes tailles permettant une intégration sur mesure : Lecteur RFID, Arrêt urgence, Touches de fonction, USB, RS-232, Lan, ...				

Liste de colisage

1 x Câble secteur CE22 1.80 m (Version AC~)	1 x Licence des logiciels (format étiquette)	1 x Fiche de Production & Tracabilité
---	--	---------------------------------------