

PLAN D'IMPLANTATION VITUS 19 NEO CUA

VUE DE DESSOUS

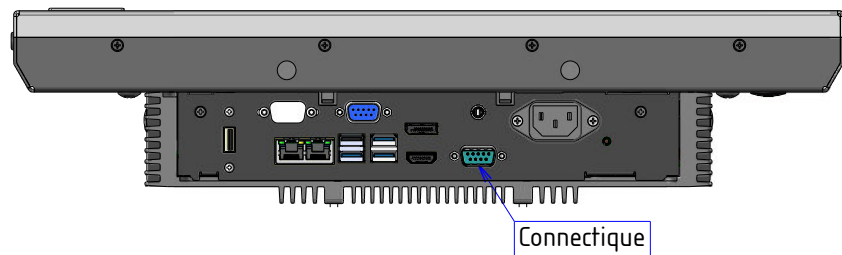

VUE DE FACE

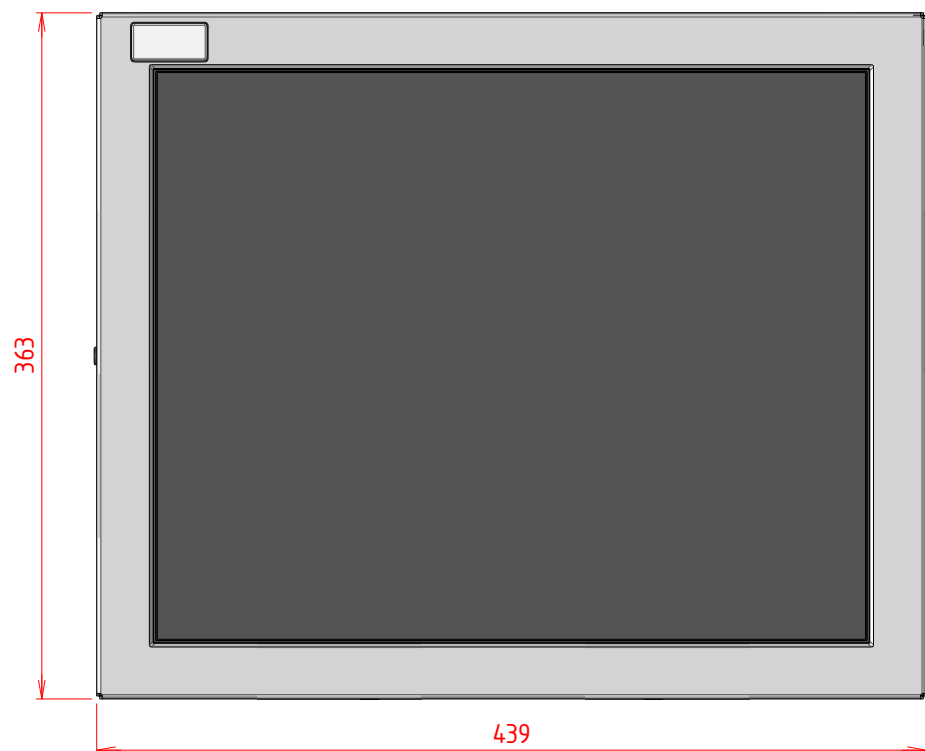

VUE DE COTE

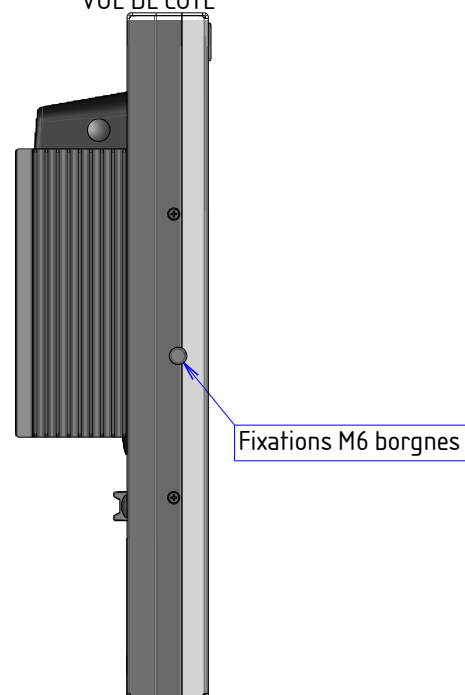

VUE ARRIERE

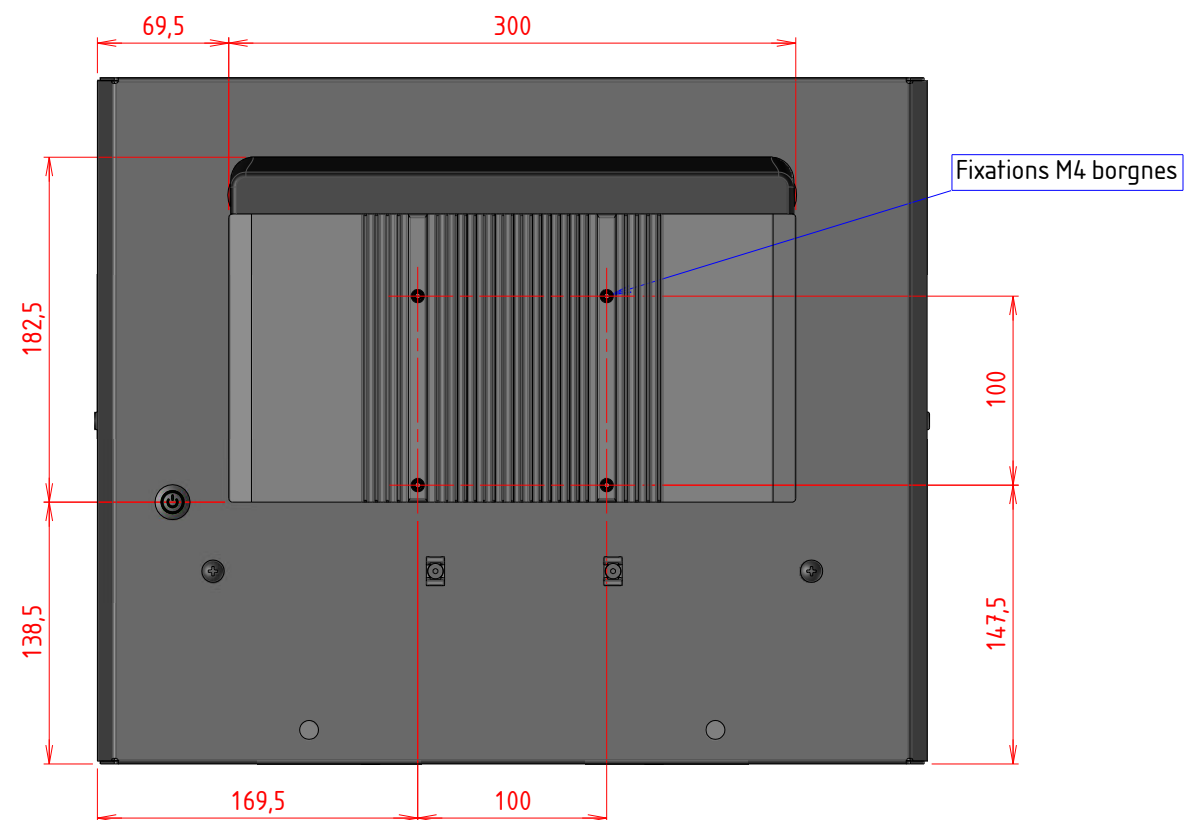

VUE DE DESSUS

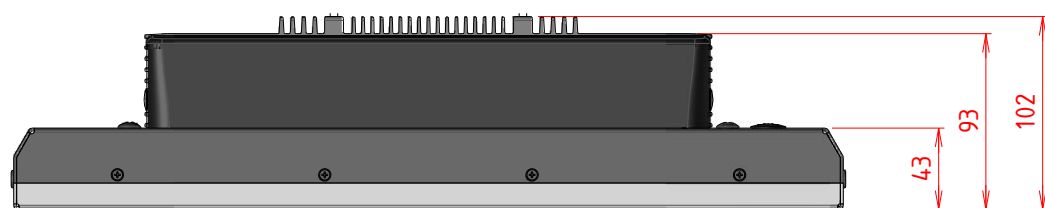

PERSPECTIVE

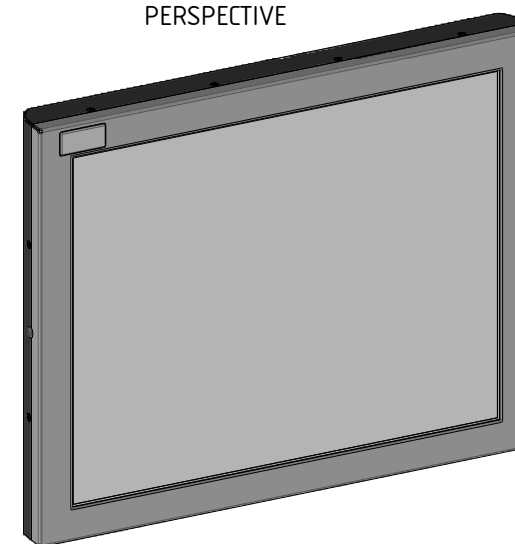

D

A